

PAPER SIZE		DRAWING NUMBER	
A		J0870	
ISS	REVISED BY:	REVISION DATE	ECO #

NOTES:

1. BLACK ASPHALT-BASED DIP COAT
2. ALL DIMENSIONS LISTED ARE NOMINAL AND IN INCHES, EXCEPT AS NOTED.
3. EXPANDED ANCHOR AREA IS 70 SQUARE INCHES.
4. INSTALLATION HOLE DIAMETER IS 6 INCHES.

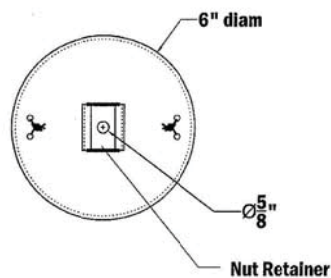
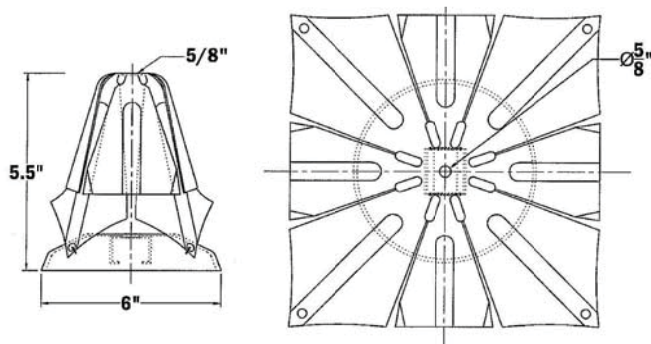

DRAWING NUMBER:		J0870	
SHEET NAME:		Sheet1	1 OF 1
DRAWING DESCRIPTION:			
ANCHOR EXPANDING (BUST)			
DRAWN BY:		DH	DESIGN DATE: 07/31/17



WWW.MACLEANPOWER.COM

This drawing contains confidential information that is the property of MacLean Power, L.L.C. ("MacLean"). Use of MacLean's confidential information without MacLean's express written consent is strictly prohibited and may expose you to legal liability. If you believe that you received this material in error, please destroy it or return it to MacLean Power, L.L.C., Kingsley Park Five, 481 Munn Rd. Suite 300, Fort Mill, SC 29715, USA.

TOLERANCES UNLESS SPECIFIED	
INCH	
0.XX	---
0.XXX	±.031
ANGLE	±1°