

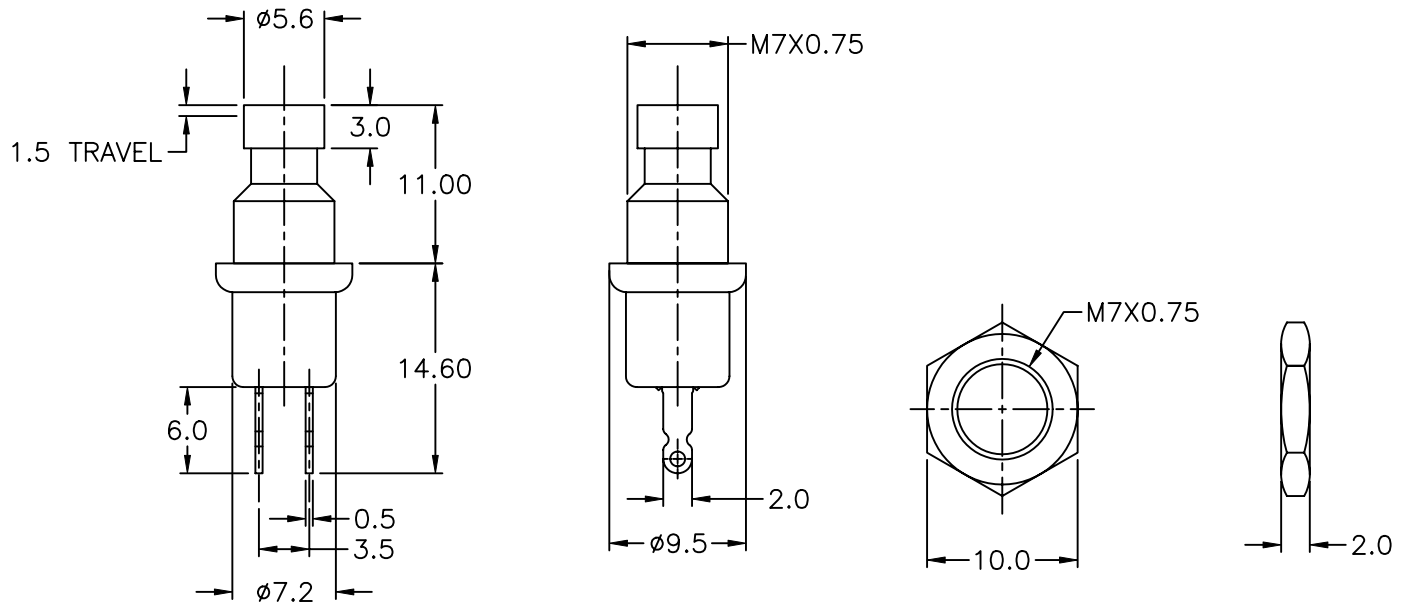

1





2

3

4

COMPONENT  
SPECIFICATIONUSE OR REPRODUCTION OF THIS DRAWING FOR THE PURPOSE OF MANUFACTURING THIS  
ARTICLE OR ANY ARTICLES SHOWN FOR ANY PURPOSE IS STRICTLY PROHIBITED WITHOUT  
WRITTEN PERMISSION FROM SENIOR INDUSTRIES, INC.

MODEL NO.	SWITCHING POSITION	
		
R18-29A	OFF	MOM
R18-29B	ON	MOM

DESIGNED:			SYM.	DATE:	DESCRIPTION OF REVISIONS:	DRAWN	APPD.
				03.05.01	NEW	RB	JF
DRAWN:	RB	03/05/01		10.28.04	New index, changed Au in Ag Plated on Contact	GAT	TF
CHECKED:	GAT	10/12/05		10.04.05	Gen dwg updated per manuf spec	GAT	JF
APPROVED:	JF	10/12/05		.			

3RD ANGLE

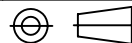

UNIT:

mm

SCALE:

2:1

REV.

C

**SENIOR  
INDUSTRIES, INC.**

TOLERANCE:

TO 1 DECIMAL PLACE:  $\pm 1$ TO 2 DECIMAL PLACES:  $\pm 0.30$ AS ANGLES:  $\pm 1/2^\circ$ 

SHEET:

PART NO:

SRP-R18-29X-X

TITLE:

PUSHBUTTON SWITCH

1 OF 2

COMPONENT  
SPECIFICATIONUSE OR REPRODUCTION OF THIS DRAWING FOR THE PURPOSE OF MANUFACTURING THIS  
ARTICLE OR ANY ARTICLES SHOWN FOR ANY PURPOSE IS STRICTLY PROHIBITED WITHOUT  
WRITTEN PERMISSION FROM SENIOR INDUSTRIES, INC.SPECIFICATIONSELECTRICAL

CONTACT RATING: 0.3 A @ 50 VDC  
 CONTACT RESISTANCE: 30 MILLIOHMS MAX.  
 INSULATION RESISTANCE: 100 MEGOHMS MIN @ 500 VDC  
 DIELECTRIC STRENGTH: 1,000 VRMS FOR 1 MINUTE

MECHANICAL

OPERATING LIFE: 20,000 CYCLES  
 OPERATING FORCE: 200g ±50g



ENVIRONMENTAL



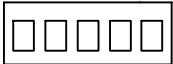

OPERATING TEMPERATURE: -30°C TO +85°C

MATERIAL

CASE: DAP, UL 94V-0  
 ACTUATOR: GLASS FILLED NYLON  
 BUSHING: BRASS, NICKEL PLATED  
 CONTACT/TERMINALS: COPPER ALLOY, SILVER PLATED

PART NUMBER BUILDER:

SERIES	MODEL NO.	CAP COLOR
SRP -		- 
	R18-29A	1 - BLUE
	R18-29B	2 - RED (STD)
		3 - BLACK (STD)
		4 - BROWN
		5 - GREEN
		6 - WHITE
		7 - GRAY
		8 - ORANGE (STD)
		9 - YELLOW
		0 - VIOLET

DESIGNED:			SYM.	DATE:	DESCRIPTION OF REVISIONS:	DRAWN	APPD.
DRAWN:	RB	03/05/01		03.05.01	NEW	RB	JF
CHECKED:	GAT	10/12/05		10.28.04	New index, changed Au in Ag Plated on Contact	GAT	TF
APPROVED:	JF	10/12/05		10.04.05	Gen dwg updated per manuf spec	GAT	JF
				.	.		

3RD ANGLE

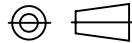

UNIT:

mm

SCALE:

REV.

C

**SENIOR  
INDUSTRIES, INC.**

TOLERANCE:

TO 1 DECIMAL PLACE: ±

TO 2 DECIMAL PLACES: ±

AS ANGLES: ± °

SHEET:

PART NO:

SRP-R18-29X-X

TITLE:

PUSHBUTTON SWITCH

2 OF 2