

COMPONENT SPECIFICATION

USE OR REPRODUCTION OF THIS DRAWING FOR THE PURPOSE OF MANUFACTURING THIS ARTICLE OR ANY ARTICLES SHOWN FOR ANY PURPOSE IS STRICTLY PROHIBITED WITHOUT WRITTEN PERMISSION FROM SENIOR INDUSTRIES, INC.

SPECIFICATIONS

ELECTRICAL

CONTACT RATING: 0.25 A @ 125 VAC
 CONTACT RESISTANCE: 20 MILLIOHMS MAX.
 INSULATION RESISTANCE: 100 MEGOHMS MIN @ 500 VDC
 DIELECTRIC STRENGTH: 1,500 VRMS

MECHANICAL

LIFE: 50,000 CYCLES

ENVIRONMENTAL

OPERATING TEMPERATURE: -30°C TO +85°C



MATERIAL

HOUSING: NYLON 6/6, UL94V-2
 ACTUATOR: GLASS FILLED NYLON
 CONTACTS/TERMINALS: COPPER ALLOY, SILVER PLATED

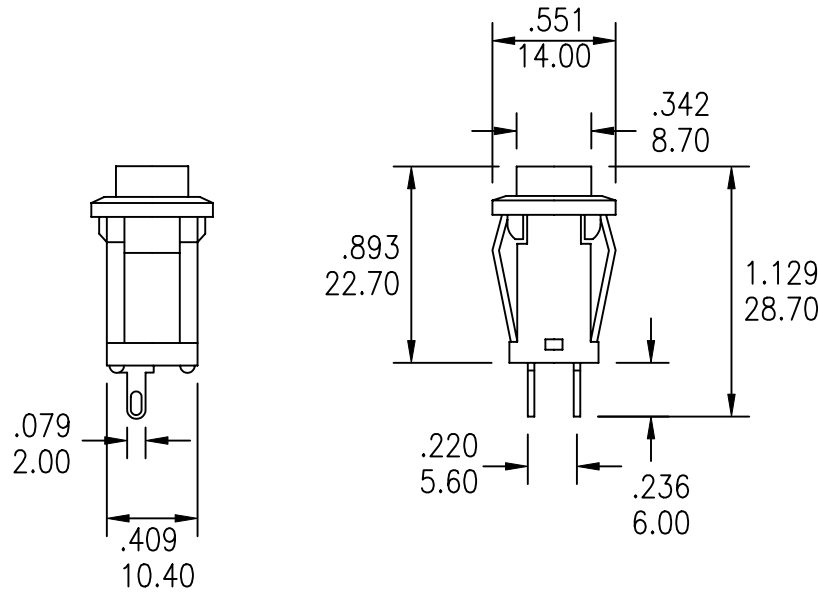

PART NUMBER BUILDER:

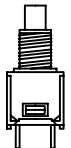
SERIES	MODEL NO.	CAP COLOR
SRP -	<input type="text"/> <input type="text"/> <input type="text"/> <input type="text"/> <input type="text"/>	- <input type="text"/>
	R18-32A	1 - BLUE
	R18-32B	2 - RED
		3 - BLACK
		4 - BROWN
		5 - GREEN
		6 - WHITE
		7 - GRAY
		8 - ORANGE
		9 - YELLOW
		0 - VIOLET



MODEL NO.	SWITCHING POSITION	
		
R18-32A	OFF-ON	LOCK
R18-32B	OFF	MOM

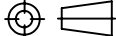

DESIGNED:			SYM.	DATE:	DESCRIPTION OF REVISIONS:	DRAWN:	APPD:	TOLERANCE:	PART NO:	SRP-R18-32X-X
DRAWN:	RB	03/05/01		03.23.01	New	RB	JF	TO 1 DECIMAL PLACE: ±.2	TITLE:	PUSHBUTTON SWITCH
CHECKED:	GAT	02/02/07		01.22.07	Corr housing mater, added 32B option	GAT	GAT			
APPROVED:	JF	02/02/07		.	.			AS ANGLES: ±1/2°	SHEET:	1 OF 1
3RD ANGLE			UNIT:	IN/mm	SCALE:	2:1	REV:	B		