

COMPONENT SPECIFICATION

USE OR REPRODUCTION OF THIS DRAWING FOR THE PURPOSE OF MANUFACTURING THIS ARTICLE OR ANY ARTICLES SHOWN FOR ANY PURPOSE IS STRICTLY PROHIBITED WITHOUT WRITTEN PERMISSION FROM SENIOR INDUSTRIES, INC.

SPECIFICATIONS

ELECTRICAL:

CONTACT RATING: 0.5A @ 125 VAC/VDC
 CONTACT RESISTANCE: 10 MILLIOHMS MAX. @ 20mA DC
 INSULATION RESISTANCE: 100 MEGOHMS MIN.
 DIELECTRIC STRENGTH: 1000 V RMS FOR 1 MINUTE

MECHANICAL:

LIFE: NO LOAD: 10,000 CYCLES MIN.
 LOAD: 6,000 CYCLES MIN.



MATERIAL:

ACTUATOR: NYLON 6/6, BLACK (STD)
 HOUSING: COLD ROLLED STEEL, NICKEL PLATED
 MOVING CONTACT SPRING: PHOSPHOR BRONZE, SILVER PLATING OR 30 μIN GOLD OVER 50 μIN NICKEL
 TERMINALS: COPPER ALLOY, SILVER PLATING OR 30 μIN GOLD OVER 50 μIN NICKEL
 BASE PLATE: .020"(0.5mm) THICK FIBER GLASS PLATE
 MOUNTING PLATE: .063"(1.6mm) THICK PBT PLASTIC

ENVIRONMENTAL:

OPERATING TEMPERATURE: -10°C TO +104°C

PART NUMBER BUILDER:

MODEL	ACTUATOR COLOR	TERMINATION	PLATING
SRS-TS-18 -			
	3-BLACK (STD)	C (PC MOUNT)	Q (SILVER) R (GOLD)

RoHS COMPLIANT



SENIOR INDUSTRIES, INC.

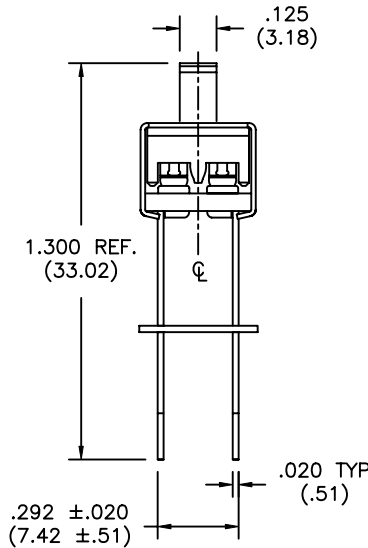
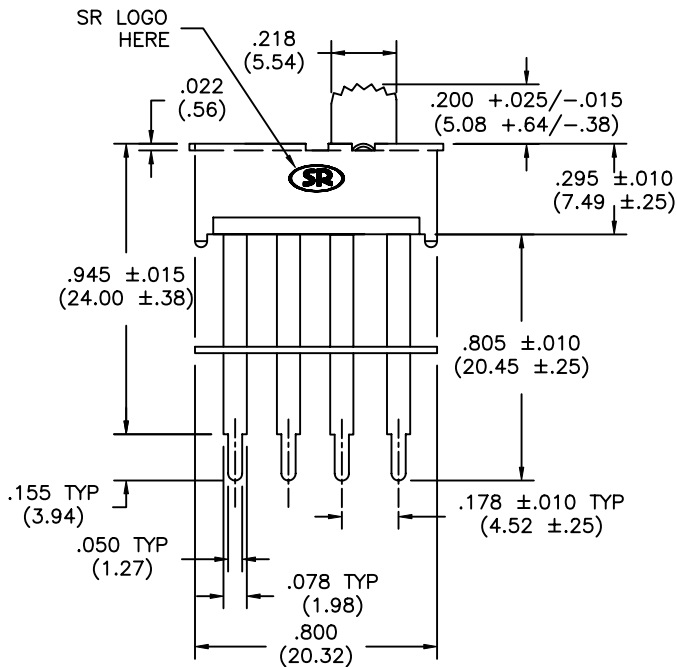
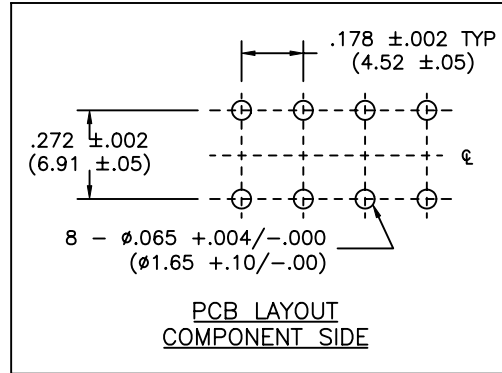
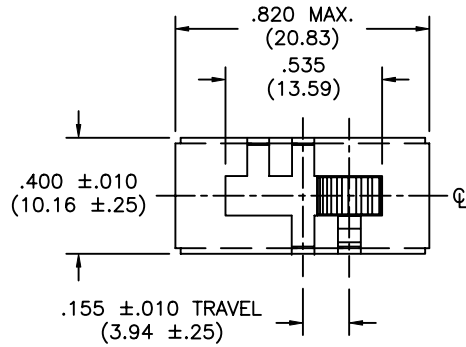

DESIGNED:		SYM.	DATE:	DESCRIPTION OF REVISIONS:	DRAWN:	APPD:
DRAWN:	GAT	06/27/06	△ 06.27.06	NEW	GAT	JF
CHECKED:	GAT	11/06/06	△ 11.06.06	Corrected Base Plate tickness fr 0.8 to 0.5mm	GAT	JF
APPROVED:	JF	11/06/06	△ . . .			

TOLERANCE:	PART NO:	TITLE:
TO 2 DECIMAL PLACE: ±.010	SRS-TS-18-3CX	SLIDE SWITCH
TO 3 DECIMAL PLACES: ±.005		

3RD ANGLE		UNIT:	IN[mm]	SCALE:	1:1	REV.	B	AS ANGLES:	±1°	SHEET:	1 OF 1
-----------	---	-------	--------	--------	-----	------	---	------------	-----	--------	--------