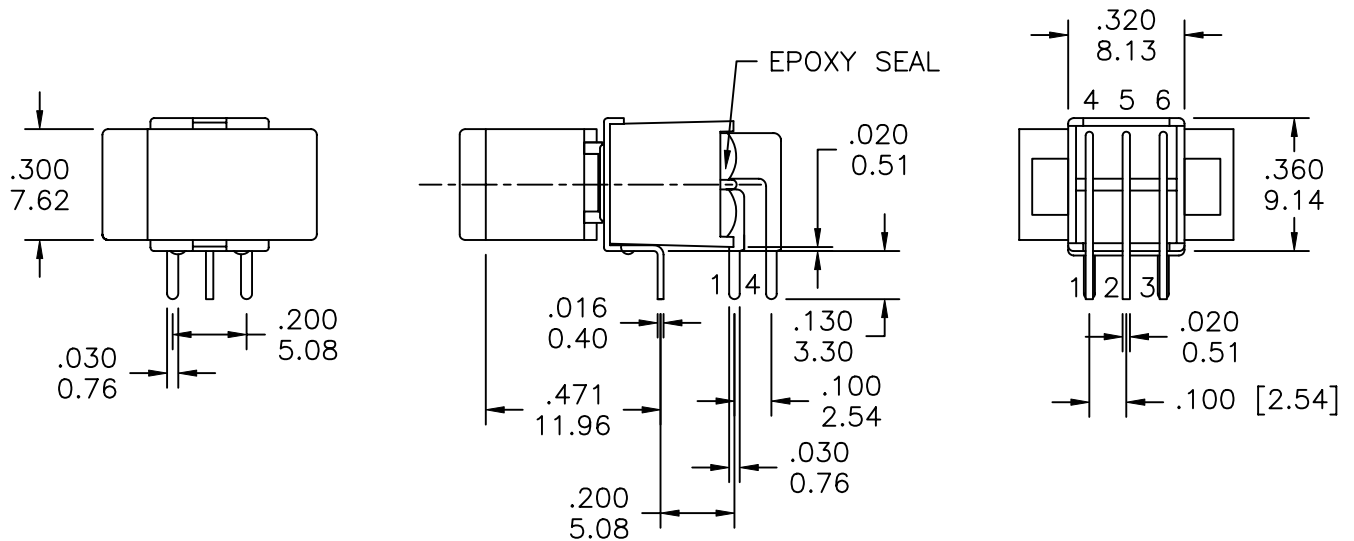

1

2

3

4

COMPONENT
SPECIFICATIONUSE OR REPRODUCTION OF THIS DRAWING FOR THE PURPOSE OF MANUFACTURING THIS
ARTICLE OR ANY ARTICLES SHOWN FOR ANY PURPOSE IS STRICTLY PROHIBITED WITHOUT
WRITTEN PERMISSION FROM SENIOR INDUSTRIES, INC.

MODEL NO.	SWITCHING POSITION		
RS7	ON	NONE	ON
CONN. TERMS	2-3 5-6	OPEN	2-1 5-4
SCHEMATIC			

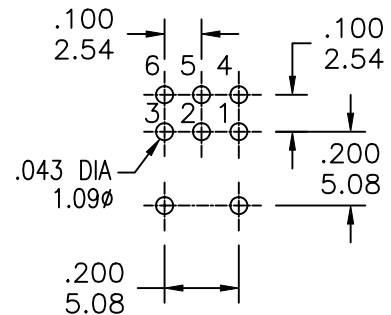
FOR PC MOUNT
TERMINATION ONLYPCB LAYOUT
COMPONENT SIDE

DESIGNED:			SYM.	DATE	DESCRIPTION OF REVISIONS	DRAWN	APPD.
DRAWN:	RB	07/12/01	△	07.12.01	NEW	RB	TF
CHECKED:	GAT	07/05/07	△	.	Recreated spec in Cad. Added Actuator options in PN builder	GAT	JF
APPROVED:	JF	07/05/07	△	.			

3RD ANGLE

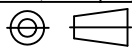

UNIT:

IN[mm]

SCALE:

2:1

REV.

B

SENIOR INDUSTRIES, INC.

TOLERANCE:

TO 1 DECIMAL PLACE: ± .2

TO 2 DECIMAL PLACES: ± .10

AS ANGLES:

SHEET:

PART NO:

SSSR-RS7-XXCXE

TITLE:

ROCKER SWITCH

1 OF 3

1

2

3

4

COMPONENT
SPECIFICATIONUSE OR REPRODUCTION OF THIS DRAWING FOR THE PURPOSE OF MANUFACTURING THIS
ARTICLE OR ANY ARTICLES SHOWN FOR ANY PURPOSE IS STRICTLY PROHIBITED WITHOUT
WRITTEN PERMISSION FROM SENIOR INDUSTRIES, INC.SPECIFICATIONSELECTRICAL

CONTACT RATING:

SILVER: 3A @ 120 VAC OR 28 VDC, 1A @ 250 VAC

GOLD: 0.4 VA MAX. @ 20 V MAX. (AC OR DC)

CONTACT RESISTANCE: 20 MILLIOHMS MAX.

INSULATION RESISTANCE: 1,000 MEGOHMS MIN. AT 500 VDC

DIELECTRIC STRENGTH: 1,000 VRMS

MECHANICAL

OPERATING LIFE: 30,000 CYCLES

ENVIRONMENTAL

OPERATING TEMPERATURE: -30°C TO +85°C

MATERIAL

CASE: GLASS FILLED NYLON 6/6, UL94V-0

ACTUATOR: NYLON, INTERNAL O-RING SEAL STANDARD

BUSHING: GLASS FILLED NYLON 6/6, UL94V-0







SUPPORT: BRASS, TIN PLATED



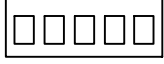

CONTACT/TERMINALS: COPPER ALLOY, SILVER OR GOLD PLATED

REGULATORY

UL AND CANADA RECOGNIZED COMPONENT. UL FILE NO. E173084.

PART NUMBER BUILDER:

SERIES	MODEL NO.	ACTUATOR	ACTUATOR COLOR	TERMINATION	CONTACT PLATING	SEAL
SSSR -		- 				
	RS7	R1 - 7.62 wide (STD) R2 - 5.84 wide	1 - BLUE 2 - RED 3 - BLACK (STD) 4 - BROWN 5 - GREEN 6 - WHITE 7 - GRAY 8 - ORANGE 9 - YELLOW 0 - VIOLET	C (PC MOUNT)	Q (SILVER) R (GOLD)	E (EPOXY)

DESIGNED:			SYM.	DATE	DESCRIPTION OF REVISIONS	DRAWN	APPD.
				07.12.01	NEW	RB	TF
DRAWN:	RB	07/12/01		07.03.07	Recreated spec in Cad. Added Actuator options in PN builder	GAT	JF
CHECKED:	GAT	07/05/07		. .			
APPROVED:	JF	07/05/07		. .			

3RD ANGLE

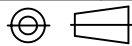

UNIT:

IN[mm]

SCALE:

REV.

B

**SENIOR
INDUSTRIES, INC.**

TOLERANCE:

TO 1 DECIMAL PLACE: ±

TO 2 DECIMAL PLACES: ±

AS ANGLES:

SHEET:

PART NO:

SSSR-RS7-XXCXE

TITLE:

ROCKER SWITCH

2 OF 3

COMPONENT SPECIFICATION

USE OR REPRODUCTION OF THIS DRAWING FOR THE PURPOSE OF MANUFACTURING THIS ARTICLE OR ANY ARTICLES SHOWN FOR ANY PURPOSE IS STRICTLY PROHIBITED WITHOUT WRITTEN PERMISSION FROM SENIOR INDUSTRIES, INC.

ACTUATOR OPTIONS:

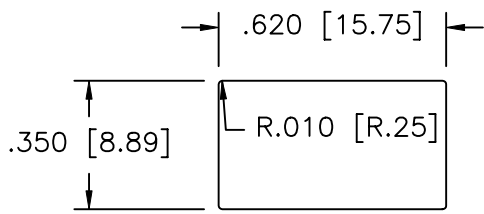

PANEL MOUNTING - R1

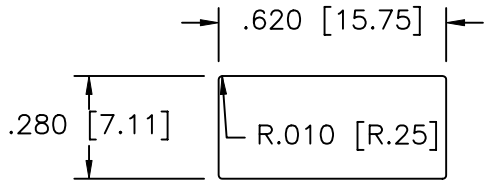
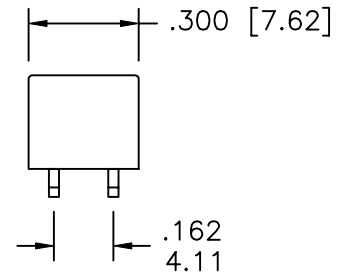
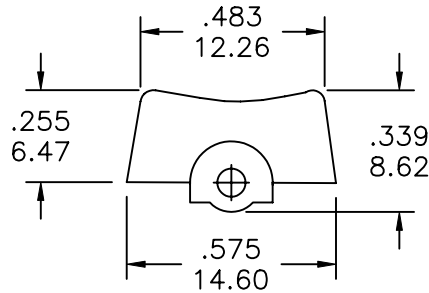

PANEL MOUNTING - R2

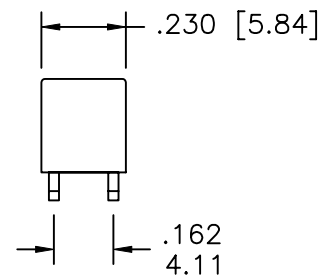
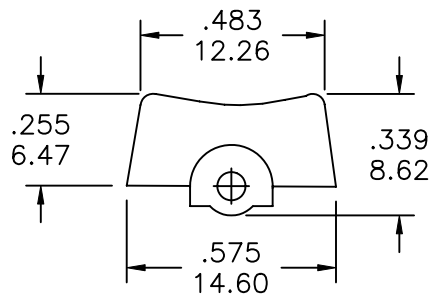

TERMINATION OPTIONS

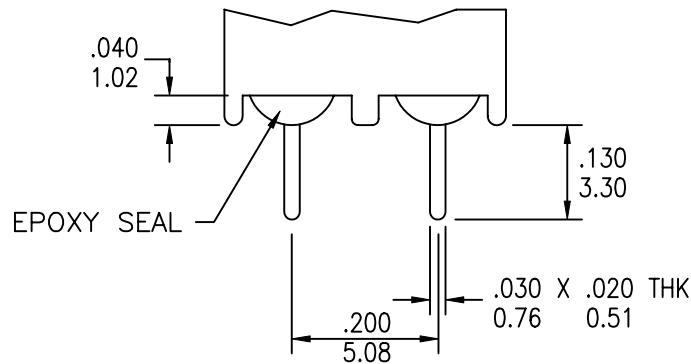

C (PC MOUNT)

DOUBLE POLE

DESIGNED:			SYM.	DATE	DESCRIPTION OF REVISIONS	DRAWN	APPD.
DRAWN:	RB	07/12/01	△	07.12.01	NEW	RB	TF
CHECKED:	GAT	07/05/07	△	07.03.07	Recreated spec in Cad. Added Actuator options in PN builder	GAT	JF
APPROVED:	JF	07/05/07	△	.			

3RD ANGLE		UNIT:	IN[mm]	SCALE:	2:1	REV.	B
-----------	--	-------	--------	--------	-----	------	---

	TOLERANCE:	PART NO:	SSSR-RS7-XXCXE	
	TO 1 DECIMAL PLACE:	± .2	TITLE:	ROCKER SWITCH
	TO 2 DECIMAL PLACES:	±.10		
	AS ANGLES:			
SHEET:		3 OF 3		